

8

7

6

5

4

3

2

1

REVISIONS

EFFECTIVITY	REV	DESCRIPTION	DATE	APPROVED
FUTURE	A	FIRST RELEASE ISSUE	10 / 20 / 03	

NOTES:

1. MOTOR ASSEMBLY SHOWN WITH OVERALL EXTERIOR DIMENSIONS.

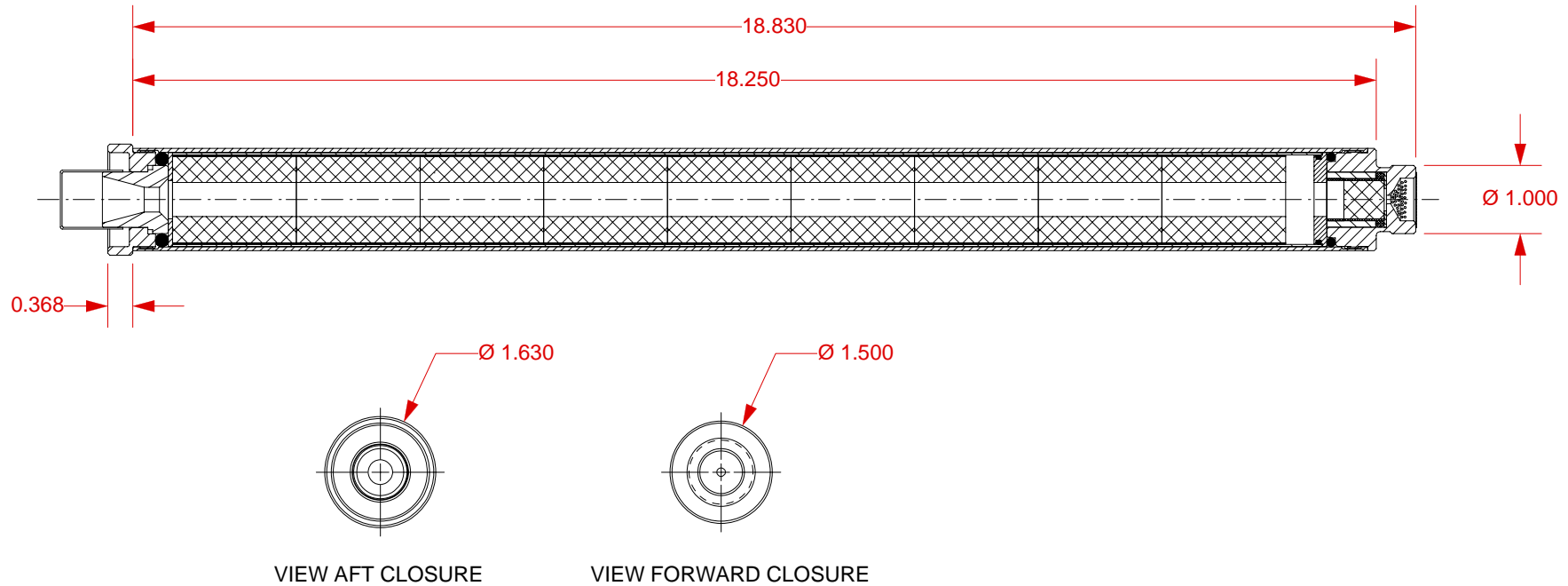

VIEW AFT CLOSURE

VIEW FORWARD CLOSURE

SUPPLIER DATA

USED IN THE FOLLOWING PRODUCTS

UNLESS OTHERWISE SPECIFIED DIMENSIONS ARE IN INCHES

QTY	PART NUMBER	DESCRIPTION	ITEM
LIST OF MATERIAL			
CONTRACT NUMBER		AEROTECH CONSUMER AEROSPACE 2113 W. 850 N. Street Cedar City, Utah 84720 (435) 865-7100 (Ph) (435) 865-7120 (Fax)	
PREP	B. ROSENFELD	10 / 03	
CHKR			
APVD		SIZE A	NUMBER ASSY DWG
APVD		SCALE 1 / 2.5	SHEET 1 OF 1

PART NUMBER	DESCRIPTION	PART NUMBER	DESCRIPTION

8

7

6

5

4

3

2

1